

SubConn® Micro Low Profile

3 contacts

Connector specifications

Voltage rating	300 V DC/AC rms
Current rating	5 A per contact (max 10 A per connector)
Insulation resistance	> 200 Mohm
Contact resistance	< 0.01 ohm
Wet matings	> 500
Temperature rating (water)	- 4 to 60°C, 25 to 140°F
Temperature rating (air)	- 40 to 60°C, - 40 to 140°F
Storage temperature rating	- 40 to 60°C, - 40 to 140°F
Qualified pressure tested	800 bar, 11,600 psi
Depth rating PEEK	300 bar, 4,350 psi

Material specifications

Connector body	Chloroprene rubber
Bulkhead body	Brass or stainless steel
Contacts	Female sockets in gold plated brass UNS - C36000 Male pins in gold plated beryllium copper
O-rings	Nitrile
Locking strap	Chloroprene rubber
Inline cable (2 ft, 60 cm)	20 AWG, 0.52 mm ² chloroprene rubber
Bulkhead leads (1 ft, 30 cm)	20 AWG, 0.52 mm ² coloured PTFE

Face view (male)



Inline cable colour code

- 1 Black
- 2 White
- 3 Red

Nominal cable outside diameter (OD)

3 conductor cable 0.250", 6.35 mm

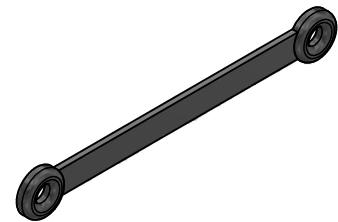
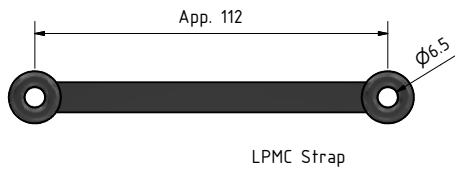
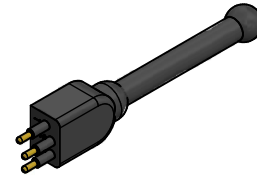
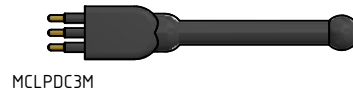
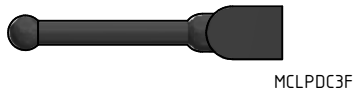
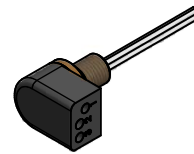
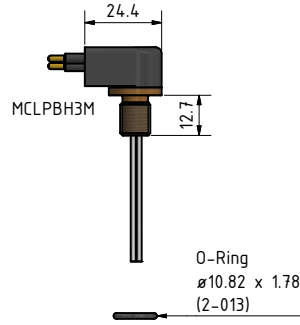
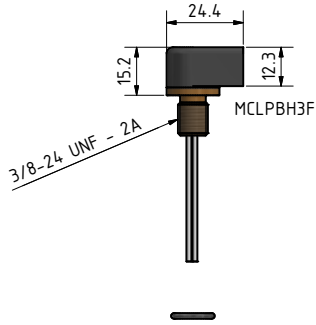
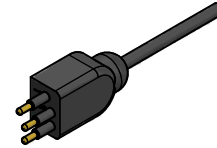
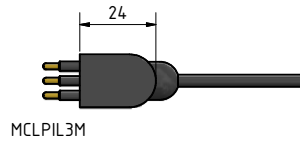
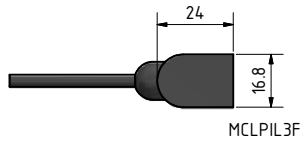

Drawing information

Dimensions in mm (1 mm = 0.03937 inch)
Threads in inches (1 inch = 25.4 mm)